

<b>TEST REPORT</b> <b>IEC 62133-2:2017+AMD1:2021</b> <b>Secondary cells and batteries containing alkaline or other non-acid electrolytes – Safety requirements for portable sealed secondary cells, and for batteries made from them, for use in portable applications – Part 2: Lithium systems</b>	
Report Number.....	: RHDTL260316029
Date of issue.....	: 2026.03.31
Total number of pages.....	: 24 pages
Tested by (name + signature).....	: QiaoLi Chen <i>Qiao Li Chen</i>
Reviewed by (name + signature).....	: Brian Liu <i>Brian Liu</i>
Approved by (name + signature).....	: Chris zhao <i>Chris zhao</i>
Testing Laboratory Name .....	: Dongguan HDTL Technology Co., Ltd.
Address .....	: Room 101, Building 1, No. 5 of Jinzhong Road, Dongcheng Street, Dongguan City, Guangdong Province, China.
Applicant's name.....	: Dongguan Xiaodian Power Technology Co., Ltd
Address.....	: 3rd Floor, Building 6, Yihengda Technology Industrial Park, No. 10 Longjiang Second Road, Xiekeng Village, Qingxi Town, Dongguan City, Guangdong Province
Test specification:	Test Report
Standard.....	: <input checked="" type="checkbox"/> IEC 62133-2:2017+AMD1:2021 <input type="checkbox"/> EN 62133-2:2017+AMD1:2021
Test item description.....	: Rechargeable Li-ion Battery
Trade Mark.....	: /
Manufacturer.....	: Dongguan Xiaodian Power Technology Co., Ltd
Address.....	: 3rd Floor, Building 6, Yihengda Technology Industrial Park, No. 10 Longjiang Second Road, Xiekeng Village, Qingxi Town, Dongguan City, Guangdong Province
Model/Type reference.....	: XD INR18650-1S6P
Ratings.....	: 3.7V 12000mAh 44.4Wh

**List of Attachments (including a total number of pages in each attachment):**

Attachment NO.1: 1 page of Photo Documentation

**Summary of testing:****Tests performed (name of test and test clause):**

clause 7.2.1 Continuous charging at constant voltage (cells)  
clause 7.3.1 External short-circuit (cell)  
clause 7.3.2 External short circuit (battery)  
clause 7.3.3 Free fall  
clause 7.3.5 Crush (cells)  
clause 7.3.6 Over-charging of battery  
clause 7.3.7 Forced discharge (cells)  
clause 7.3.8.1 Vibration  
clause 7.3.8.2 Mechanical shock  
clause 7.3.9 Forced internal short circuit (cells)  
clause 7.2.2A Temperature cycle (cells)  
The samples comply with the requirements of IEC 62133-2:2017+AMD1:2021

**Testing location:**

Dongguan HDTL Technology Co., Ltd.  
Room 101, Building 1, No. 5 of Jinzhong Road,  
Dongcheng Street, Dongguan City, Guangdong  
Province, China.

**Summary of compliance with National Differences (List of countries addressed):**

**The product fulfils the requirements of  
IEC 62133-2:2017 + AMD1:2021  
EN 62133-2:2017 + AMD1:2021**

**Copy of marking plate:**

The artwork below may be only a draft. The use of certification marks on a product must be authorized by the respective NCBs that own these marks.

3.7V 12000mAh 44.4Wh

Rechargeable Li-ion Battery

XD INR18650-1S6P

INR18650-6

YYYYMMDD

Dongguan Electric Power Technology Co., Ltd

Red +

Black -

WARNING:

Do not disassemble, puncture, crush, heat, or burn.

Anti-swallowing warning



Remark: "YYYY" means to years; "MM" means to months; "DD" means to days

<b>Test item particulars</b> .....	: Rechargeable Li-ion Battery
<b>Classification of installation and use</b> .....	: To be defined in final product
<b>Supply connection</b> .....	: Supply by connector
<b>Recommend charging method declared by the manufacturer</b> .....	: Charge at constant current 1200mA until voltage reaches 4.2V, then charge at constant voltage 4.2V till charge current is 0.02C.
<b>Discharge current(0.2 It A)</b> .....	: 3500mA
<b>Maximum discharging current</b> .....	: 8000mA
<b>Specified final voltage</b> .....	: 2.75V
<b>Recommend of charging limit for lithium system</b>	
<b>Upper limit charging voltage per cell</b> .....	: 4.2V
<b>Maximum charging current</b> .....	: 2400mA
<b>Charging temperature upper limit</b> .....	: 45°C
<b>Charging temperature lower limit</b> .....	: 0°C
<b>Polymer cell electrolyte type</b> .....	: <input type="checkbox"/> gel polymer <input type="checkbox"/> solid polymer <input checked="" type="checkbox"/> N/A
<b>Possible test case verdicts:</b>	
- test case does not apply to the test object.....	: N/A
- test object does meet the requirement.....	: P (Pass)
- test object does not meet the requirement.....	: F (Fail)
<b>Testing</b> .....	
<b>Date of receipt of test item</b> .....	: 2026.03.16
<b>Date (s) of performance of tests</b> .....	: 2026.03.16 ~ 2026.03.31
<b>General remarks:</b>	
The test results presented in this report relate only to the object tested.	
This report shall not be reproduced, except in full, without the written approval of the Issuing testing laboratory.	
"(See Enclosure #)" refers to additional information appended to the report.	
"(See appended table)" refers to a table appended to the report.	
<b>Throughout this report a <input type="checkbox"/> comma / <input checked="" type="checkbox"/> point is used as the decimal separator.</b>	
<b>Name and address of factory (ies)</b> .....	: Dongguan Xiaodian Power Technology Co., Ltd 3rd Floor, Building 6, Yihengda Technology Industrial Park, No. 10 Longjiang Second Road, Xiekeng Village, Qingxi Town, Dongguan City, Guangdong Province

**General product information:**

This battery is constructed with 6 Li-ion Cell in 1S6P, and PCB circuit, provides with overcharge, over-discharge, short-circuits proof circuit as part of protection effect.

Parameters:

Product name	Cell	Battery
Type/model	INR18650-2000mAh	XD INR18650-1S6P
Nominal capacity	2000mAh	12000mAh
Nominal voltage	3.7V	3.7V
Nominal charge current	400mA	1200mA
Nominal discharge current	400mA	3500mA
Maximum charge current	2000mA	2400mA
Maximum discharge current	2000mA	8000mA
Nominal charging voltage	4.2V	4.2V
Upper limit charging voltage	4.2V	4.2V
Discharging Cut-off voltage	2.75V	2.75V
Charging temperature	0~45°C	0~45°C

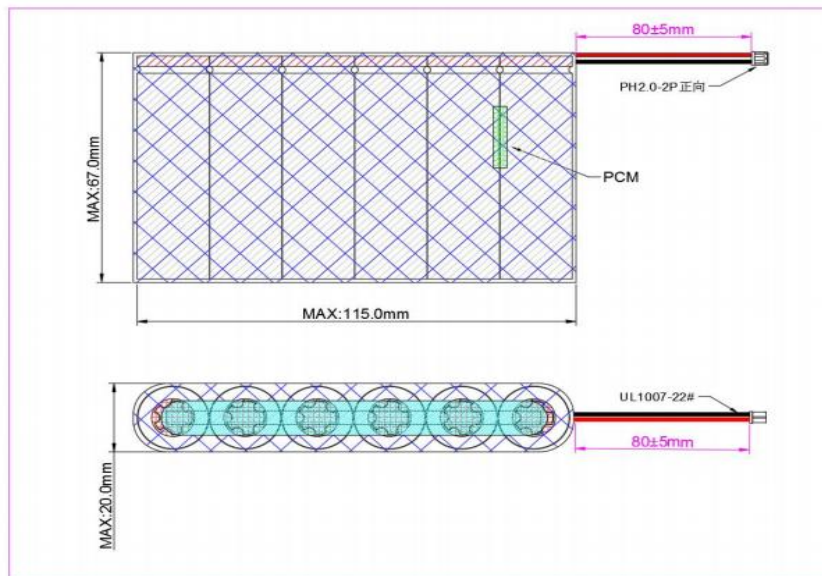
**Construction:**

外露线长 Exposed line length (L)	80±5mm
宽度 Width (W)	Max 115.0mm
高度 High (H)	Max 67.0mm
厚度 Thickness (T)	Max 20.0mm
端子电子线规格: Electronic wire specifications	PH2.0-2P 线序: 红, 黑, UL1007, 22AWG 线 红 =100mm, 黑=110mm 末端剥线浸锡 2-2.5mm
喷码内容: Spurt the code content	喷码 (生产日期为变动码, 以实际生产日期为准) 具体内容按客户要求执行

Circuit diagram:

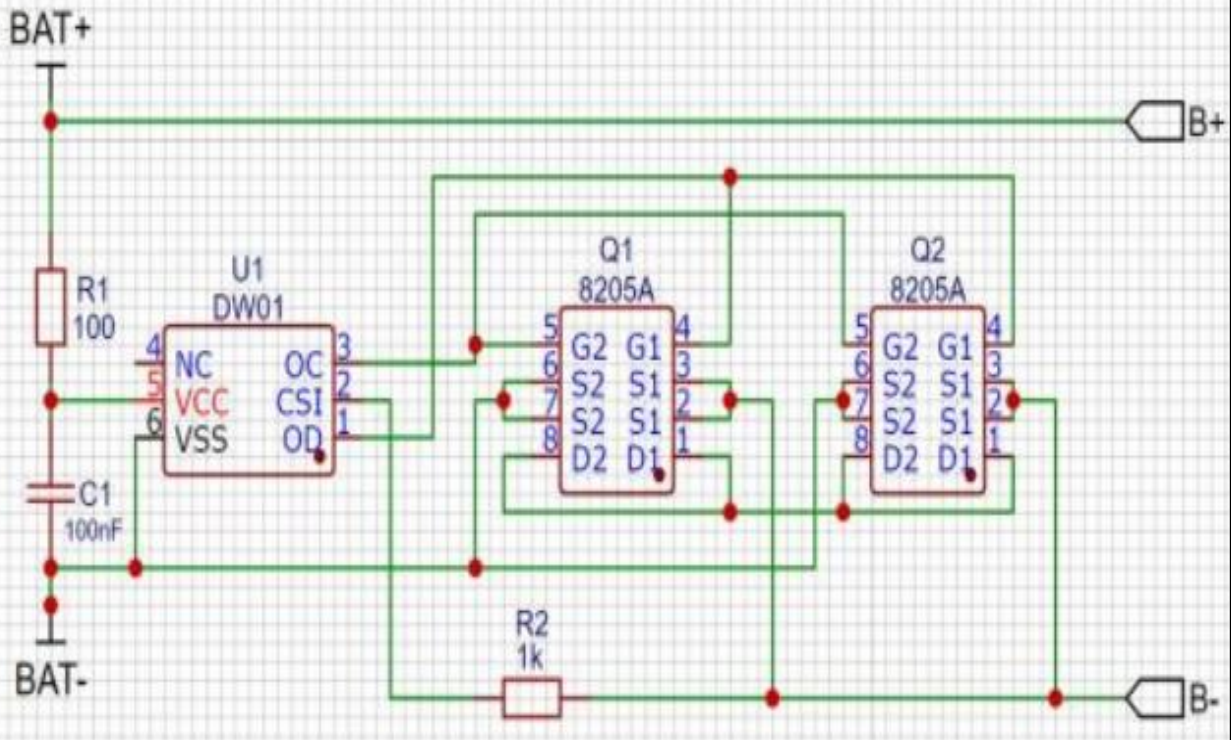

IEC 62133-2			
Clause	Requirement + Test	Result - Remark	Verdict
<b>4</b>	<b>PARAMETER MEASUREMENT TOLERANCES</b>		P
	Parameter measurement tolerances		P
<b>5</b>	<b>GENERAL SAFETY CONSIDERATIONS</b>		P
<b>5.1</b>	<b>General</b>		P
	Cells and batteries so designed and constructed that they are safe under conditions of both intended use and reasonably foreseeable misuse		P
<b>5.2</b>	<b>Insulation and wiring</b>		P
	The insulation resistance between the positive terminal and externally exposed metal surfaces of the battery (excluding electrical contact surfaces) is not less than 5 MΩ	No metal surface exists.	N/A
	Insulation resistance (MΩ)..... :		—
	Internal wiring and insulation are sufficient to withstand maximum anticipated current, voltage and temperature requirements		P
	Orientation of wiring maintains adequate clearances and creepage distances between conductors		P
	Mechanical integrity of internal connections accommodates reasonably foreseeable misuse		P
<b>5.3</b>	<b>Venting</b>		P
	Battery cases and cells incorporate a pressure relief mechanism or are constructed so that they relieve excessive internal pressure at a value and rate that will preclude rupture, explosion and self-ignition		P
	Encapsulation used to support cells within an outer casing does not cause the battery to overheat during normal operation nor inhibit pressure relief		N/A
<b>5.4</b>	<b>Temperature, voltage and current management</b>		P
	Batteries are designed such that abnormal temperature rise conditions are prevented	Overcharge, over discharge, over current and short-circuit proof circuit used in this battery. See tests of clause 7.	P
	Batteries are designed to be within temperature, voltage and current limits specified by the cell manufacturer	See above.	P
	Batteries are provided with specifications and charging instructions for equipment manufacturers so that specified chargers are designed to maintain charging within the temperature, voltage and current limits specified	The charging limits specified in the battery specifications.	P

IEC 62133-2			
Clause	Requirement + Test	Result - Remark	Verdict
<b>5.5</b>	<b>Terminal contacts</b>		P
	The size and shape of the terminal contacts ensure that they can carry the maximum anticipated current		P
	External terminal contact surfaces are formed from conductive materials with good mechanical strength and corrosion resistance		P
	Terminal contacts are arranged to minimize the risk of short circuits		P
<b>5.6</b>	<b>Assembly of cells into batteries</b>		P
5.6.1	General		P
	Each battery has an independent control and protection for current, voltage, temperature and any other parameter required for safety and to maintain the cells within their operating region	Overcharge, overdischarge, overcurrent and short-circuit proof circuit used in this battery	P
	This protection may be provided external to the battery such as within the charger or the end devices		N/A
	If protection is external to the battery, the manufacturer of the battery provide this safety relevant information to the external device manufacturer for implementation		N/A
	If there is more than one battery housed in a single battery case, each battery has protective circuitry that can maintain the cells within their operating regions		N/A
	Manufacturers of cells specify current, voltage and temperature limits so that the battery manufacturer/designer may ensure proper design and assembly	Current, voltage and temperature limits specified by cell manufacturer.	P
	Batteries that are designed for the selective discharge of a portion of their series connected cells incorporate circuitry to prevent operation of cells outside the limits specified by the cell manufacturer		P
	Protective circuit components are added as appropriate and consideration given to the end-device application		N/A
	The manufacturer of the battery provide a safety analysis of the battery safety circuitry with a test report including a fault analysis of the protection circuit under both charging and discharging conditions confirming the compliance		P
5.6.2	Design recommendation		P

IEC 62133-2			
Clause	Requirement + Test	Result - Remark	Verdict
	For the battery consisting of a single cell or a single cellblock, it is recommended that the charging voltage of the cell does not exceed the upper limit of the charging voltage specified in Table 2	1S6P, Max. charging voltage of each cell: 4.2V, not exceed 4.2V specified in Table 2.	P
	For the battery consisting of series-connected plural single cells or series-connected plural cellblocks, it is recommended that the voltages of any one of the single cells or single cellblocks does not exceed the upper limit of the charging voltage, specified in Table 2, by monitoring the voltage of every single cell or the single cellblocks		N/A
	For the battery consisting of series-connected plural single cells or series-connected plural cellblocks, it is recommended that charging is stopped when the upper limit of the charging voltage is exceeded for any one of the single cells or single cellblocks by measuring the voltage of every single cell or the single cellblocks		P
	For batteries consisting of series-connected cells or cell blocks, nominal charge voltage are not counted as an overcharge protection		P
	For batteries consisting of series-connected cells or cell blocks, cells have closely matched capacities, be of the same design, be of the same chemistry and be from the same manufacturer		P
	It is recommended that the cells and cell blocks are not discharged beyond the cell manufacturer's specified final voltage	Final voltage of cell: 2.75V.	P
	For batteries consisting of series-connected cells or cell blocks, cell balancing circuitry are incorporated into the battery management system		N/A
5.6.3	Mechanical protection for cells and components of batteries		P
	Mechanical protection for cells, cell connections and control circuits within the battery are provided to prevent damage as a result of intended use and reasonably foreseeable misuse	Mechanical protection for cell connections and control circuits provided.	P
	The mechanical protection can be provided by the battery case or it can be provided by the end product enclosure for those batteries intended for building into an end product	Mechanical protection is provided by the final product housing	N/A
	The battery case and compartments housing cells are designed to accommodate cell dimensional tolerances during charging and discharging as recommended by the cell manufacturer		N/A

IEC 62133-2			
Clause	Requirement + Test	Result - Remark	Verdict
	For batteries intended for building into a portable end product, testing with the battery installed within the end product is considered when conducting mechanical tests		N/A
<b>5.7</b>	<b>Quality plan</b>		P
	The manufacturer prepares and implements a quality plan that defines procedures for the inspection of materials, components, cells and batteries and which covers the whole process of producing each type of cell or battery	ISO 9001 certified factory.	P
<b>5.8</b>	<b>Battery safety components</b>		P
<b>6</b>	<b>TYPE TEST AND SAMPLE SIZE</b>		P
	Tests are made with the number of cells or batteries specified in Table 1 using cells or batteries that are not more than six months old		P
	The internal resistance of coin cells are measured in accordance with Annex D. Coin cells with internal resistance less than or equal to 3 $\Omega$ are tested in accordance with Table 1	Not coin cells	N/A
	Unless otherwise specified, tests are carried out in an ambient temperature of 20 °C $\pm$ 5 °C		P
	The safety analysis of 5.6.1 identify those components of the protection circuit that are critical for short-circuit, overcharge and over discharge protection		P
	When conducting the short-circuit test, consideration is given to the simulation of any single fault condition that is likely to occur in the protecting circuit that would affect the short-circuit test	See clause 7.3.2.	P
<b>7</b>	<b>SPECIFIC REQUIREMENTS AND TESTS</b>		P
<b>7.1</b>	<b>Charging procedure for test purposes</b>		P
7.1.1	First procedure		P
	This charging procedure applies to subclauses other than those specified in 7.1.2		P
	Unless otherwise stated in this document, the charging procedure for test purposes is carried out in an ambient temperature of 20 °C $\pm$ 5 °C, using the method declared by the manufacturer		P
	Prior to charging, the battery has been discharged at 20 °C $\pm$ 5 °C at a constant current of 0,2 It A down to a specified final voltage		P

IEC 62133-2			
Clause	Requirement + Test	Result - Remark	Verdict
7.1.2	Second procedure		P
	This charging procedure applies only to 7.3.1, 7.3.4, 7.3.5, and 7.3.9		P
	After stabilization for 1 h to 4 h, at an ambient temperature of the highest test temperature and the lowest test temperature, respectively, as specified in Table 2, cells are charged by using the upper limit charging voltage and maximum charging current, until the charging current is reduced to 0,05 It A, using a constant current to constant voltage charging method	Charge temperature 0~45°C declared. 45°C used for upper limit tests temperature, 0°C used for lower limit tests temperature.	P
<b>7.2</b>	<b>Intended use</b>		P
7.2.1	Continuous charging at constant voltage (cells)	Tested complied.	P
	Fully charged cells are subjected for 7 days to a charge using the charging method for current and standard voltage specified by the cell manufacturer		P
	Results: no fire, no explosion, no leakage.....:	(See appended table 7.2.1)	P
7.2.2	Case stress at high ambient temperature (battery)	No plastic case	N/A
	Oven temperature (°C).....:		N/A
	Results: no physical distortion of the battery case resulting in exposure of internal protective components and cells		N/A
<b>7.3</b>	<b>Reasonably foreseeable misuse</b>		P
7.3.1	External short-circuit (cell)	Tested complied.	P
	The cells were tested until one of the following occurred:		P
	- 24 hours elapsed; or		N/A
	- The case temperature declined by 20 % of the maximum temperature rise		P
	Results: no fire, no explosion.....:	(See Table 7.3.1)	P
7.3.2	External short-circuit (battery)	Tested complied.	P
	The batteries were tested until one of the following occurred:		P
	- 24 hours elapsed; or		P
	- The case temperature declined by 20 % of the maximum temperature rise		N/A
	In case of rapid decline in short circuit current, the battery pack remained on test for an additional one hour after the current reached a low end steady state condition		N/A

IEC 62133-2			
Clause	Requirement + Test	Result - Remark	Verdict
	A single fault in the discharge protection circuit is conducted on one to four (depending upon the protection circuit) of the five samples before conducting the short-circuit test		P
	A single fault applies to protective component parts such as MOSFET (metal oxide semiconductor field-effect transistor), fuse, thermostat or positive temperature coefficient (PTC) thermistor		P
	Results: no fire, no explosion.....	(See appended table 7.3.2)	P
7.3.3	Free fall	Tested complied.	P
	Results: no fire, no explosion		P
7.3.4	Thermal abuse (cells)	Tested complied.	P
	Oven temperature (°C).....	Raised at 5°C/min ± 2°C/min to a temperature of 130°C ± 2°C and remained for 30mins.	—
	Results: no fire, no explosion		P
7.3.5	Crush (cells)	Tested complied.	P
	The crushing force was released upon:		P
	- The maximum force of 13 kN ± 0,78 kN has been applied; or		P
	- An abrupt voltage drop of one-third of the original voltage has been obtained		N/A
	Results: no fire, no explosion.....	(See appended table 7.3.5)	P
7.3.6	Over-charging of battery	Tested complied.	P
	The supply voltage which is:		P
	- 1,4 times the upper limit charging voltage presented in Table A.1 (but not to exceed 6,0 V) for single cell/cell block batteries or	1S6P	P
	- 1,2 times the upper limit charging voltage resented in Table A.1 per cell for series connected multi-cell batteries, and		N/A
	- Sufficient to maintain a current of 2,0 It A throughout the duration of the test or until the supply voltage is reached		P
	Test was continued until the temperature of the outer casing:		P
	- Reached steady state conditions (less than 10 °C change in 30-minute period); or		N/A
	- Returned to ambient		P
	Results: no fire, no explosion.....	(See appended table 7.3.6)	P

IEC 62133-2			
Clause	Requirement + Test	Result - Remark	Verdict
7.3.7	Forced discharge (cells)	Tested complied.	P
	Discharge a single cell to the lower limit discharge voltage specified by the cell manufacturer		P
	The discharged cell is then subjected to a forced discharge at 1 It A to the negative value of the upper limit charging voltage		P
	- The discharge voltage reaches the negative value of upper limit charging voltage within the testing duration. The voltage is maintained at the negative value of the upper limit charging voltage by reducing the current for the remainder of the testing duration		N/A
	- The discharge voltage does not reach the negative value of upper limit charging voltage within the testing duration. The test is terminated at the end of the testing duration		P
	Results: no fire, no explosion.....:	(See appended table 7.3.7)	P
7.3.8	Mechanical tests (batteries)		P
7.3.8.1	Vibration	Tested complied.	P
	Results: no fire, no explosion, no rupture, no leakage or venting.....:	(See appended table 7.3.8.1)	P
7.3.8.2	Mechanical shock	Tested complied.	P
	Results: no leakage, no venting, no rupture, no explosion and no fire.....:	(See appended table 7.3.8.2)	P
7.3.9	Design evaluation – Forced internal short-circuit (cells)	Tested complied.	P
	The cells complied with national requirement for.....:	France, Japan, Republic of Korea and Switzerland.	—
	The pressing was stopped upon:		P
	- A voltage drop of 50 mV has been detected; or		N/A
	- The pressing force of 800 N (cylindrical cells) or 400 N (prismatic cells) has been reached	800 N (cylindrical cells)	P
	Results: no fire.....:	(See appended table 7.3.9)	P
<b>8</b>	<b>INFORMATION FOR SAFETY</b>		P
<b>8.1</b>	<b>General</b>		P
	Manufacturers of secondary cells provides information about current, voltage and temperature limits of their products	Information for safety mentioned in manufacturer's specifications.	P

IEC 62133-2			
Clause	Requirement + Test	Result - Remark	Verdict
	Manufacturers of batteries provides information regarding how to minimize and mitigate hazards to equipment manufacturers or end-users	Information for safety mentioned in manufacturer's specifications.	P
	Systems analyses are performed by device manufacturers to ensure that a particular battery design prevents hazards from occurring during use of a product		N/A
	As appropriate, any information relating to hazard avoidance resulting from a system analysis is provided to the end user		N/A
	Do not allow children to replace batteries without adult supervision		N/A
<b>8.2</b>	<b>Small cell and battery safety information</b>	Not small cell or battery	N/A
	The following warning language is to be provided with the information packaged with the small cells and batteries or equipment using them:		N/A
	- Keep small cells and batteries which are considered swallowable out of the reach of children		N/A
	- Swallowing may lead to burns, perforation of soft tissue, and death. Severe burns can occur within 2 h of ingestion		N/A
	- In case of ingestion of a cell or battery, seek medical assistance promptly		N/A
<b>9</b>	<b>MARKING</b>		P
<b>9.1</b>	<b>Cell marking</b>	The final product is battery.	N/A
	Cells are marked as specified in IEC 61960, except coin cells		N/A
	Coin cells whose external surface area is too small to accommodate the markings on the cells show the designation and polarity		N/A
	By agreement between the cell manufacturer and the battery and/or end product manufacturer, component cells used in the manufacture of a battery need not be marked		N/A
<b>9.2</b>	<b>Battery marking</b>	See marking plate on page 5	P
	Batteries are marked as specified in IEC 61960, except for coin batteries		P
	Coin batteries whose external surface area is too small to accommodate the markings on the batteries show the designation and polarity	Not coin battery.	N/A

IEC 62133-2			
Clause	Requirement + Test	Result - Remark	Verdict
	Batteries are marked with an appropriate caution statement		P
	- Terminals have clear polarity marking on the external surface of the battery, or		N/A
	- Not be marked with polarity markings if the design of the external connector prevents reverse polarity connections	DC connector used	P
<b>9.3</b>	<b>Caution for ingestion of small cells and batteries</b>	Not small cell or battery	N/A
	Coin cells and batteries identified as small batteries include a caution statement regarding the hazards of ingestion in accordance with 8.2		N/A
	Small cells and batteries are intended for direct sale in consumer-replaceable applications, caution for ingestion is given on the immediate package		N/A
<b>9.4</b>	<b>Other information</b>		P
	The following information are marked on or supplied with the battery:		P
	- Storage and disposal instructions	Information for storage and disposal instructions mentioned in manufacturer's specifications.	P
	- Recommended charging instructions	Information for recommended charging instructions mentioned in manufacturer's specifications.	P
<b>10</b>	<b>PACKAGING AND TRANSPORT</b>		N/A
	Packaging for coin cells are not be small enough to fit within the limits of the ingestion gauge of Figure 3		N/A
<b>ANNEX A</b>	<b>CHARGING AND DISCHARGING RANGE OF SECONDARY LITHIUM ION CELLS FOR SAFE USE</b>		P
<b>A.1</b>	<b>General</b>		P
<b>A.2</b>	<b>Safety of lithium ion secondary battery</b>	Complied.	P
<b>A.3</b>	<b>Consideration on charging voltage</b>	Complied.	P
A.3.1	General		P
A.3.2	Upper limit charging voltage	4.2V	P
A.3.2.1	General		P
A.3.2.2	Explanation of safety viewpoint		N/A

IEC 62133-2			
Clause	Requirement + Test	Result - Remark	Verdict
A.3.2.3	Safety requirements, when different upper limit charging voltage is applied		N/A
<b>A.4</b>	<b>Consideration of temperature and charging current</b>		P
A.4.1	General		P
A.4.2	Recommended temperature range	See A.4.2.2.	P
A.4.2.1	General		P
A.4.2.2	Safety consideration when a different recommended temperature range is applied	Charging temperature range declared by manufacturer is 0~45°C	P
A.4.3	High temperature range	45°C.	N/A
A.4.3.1	General		N/A
A.4.3.2	Explanation of safety viewpoint		N/A
A.4.3.3	Safety considerations when specifying charging conditions in the high temperature range		N/A
A.4.3.4	Safety considerations when specifying a new upper limit in the high temperature range		N/A
A.4.4	Low temperature range	0°C.	N/A
A.4.4.1	General		N/A
A.4.4.2	Explanation of safety viewpoint		N/A
A.4.4.3	Safety considerations, when specifying charging conditions in the low temperature range		N/A
A.4.4.4	Safety considerations when specifying a new lower limit in the low temperature range		N/A
A.4.5	Scope of the application of charging current		P
A.4.6	Consideration of discharge		P
A.4.6.1	General		P
A.4.6.2	Final discharge voltage and explanation of safety viewpoint	Cell specified final voltage: 2.75V, not below 2.75V specified by cell manufacturer.	P
A.4.6.3	Discharge current and temperature range		P
A.4.6.4	Scope of application of the discharging current		P
<b>A.5</b>	<b>Sample preparation</b>		P
A.5.1	General		P
A.5.2	Insertion procedure for nickel particle to generate internal short		P
A.5.3	Disassembly of charged cell		P

IEC 62133-2			
Clause	Requirement + Test	Result - Remark	Verdict
A.5.4	Shape of nickel particle		P
A.5.5	Insertion of nickel particle in cylindrical cell		P
A.5.5.1	Insertion of nickel particle in winding core		P
A.5.5.2	Marking the position of the nickel particle on both ends of the winding core of the separator		P
A.5.6	Insertion of nickel particle in prismatic cell		N/A
<b>A.6</b>	<b>Experimental procedure of the forced internal short-circuit test</b>		P
A.6.1	Material and tools for preparation of nickel particle		P
A.6.2	Example of a nickel particle preparation procedure		P
A.6.3	Positioning (or placement) of a nickel particle		P
A.6.4	Damaged separator precaution		P
A.6.5	Caution for rewinding separator and electrode		P
A.6.6	Insulation film for preventing short-circuit		P
A.6.7	Caution when disassembling a cell		P
A.6.8	Protective equipment for safety		P
A.6.9	Caution in the case of fire during disassembling		P
A.6.10	Caution for the disassembling process and pressing the electrode core		P
A.6.11	Recommended specifications for the pressing device		P
<b>ANNEX B</b>	<b>RECOMMENDATIONS TO EQUIPMENT MANUFACTURERS AND BATTERY ASSEMBLERS</b>		<b>P</b>
<b>ANNEX C</b>	<b>RECOMMENDATIONS TO THE END-USERS</b>		<b>P</b>
<b>ANNEX D</b>	<b>MEASUREMENT OF THE INTERNAL AC RESISTANCE FOR COIN CELLS</b>		N/A
<b>D.1</b>	<b>General</b>		N/A
<b>D.2</b>	<b>Method</b>		N/A
	A sample size of three coin cells is required for this measurement		N/A
	Coin cells with an internal resistance greater than 3 $\Omega$ require no further testing..... :		N/A
	Coin cells with an internal resistance less than or equal to 3 $\Omega$ are subjected to the testing according to Clause 6 and Table 1		N/A

IEC 62133-2			
Clause	Requirement + Test	Result - Remark	Verdict
<b>ANNEX E</b>	<b>PACKAGING AND TRANSPORT</b>		<b>P</b>
<b>ANNEX F</b>	<b>COMPONENT STANDARDS REFERENCES</b>		<b>N/A</b>

Component name	Manufacturer/ trademark	Type/model	Technical data	Standard	Mark(s) of conformity
Cell	Dongguan Liyang Battery Technology Co., Ltd.	INR18650-2000mAh	3.7V, 2000mAh	IEC 62133-2:2017/AM D1:2021	Tested with appliance
-Positive electrode	Jiangxi Chaoshan New Energy Technology Co., LTD	LMO-4AR	Lithium manganate	--	Tested with appliance
-Negative electrode	Shenzhen Xinmao New Energy Technology Co., Ltd.	K6	Dimensions	--	Tested with appliance
-Electrolyte	Hunan Dajing New Material Co., LTD	HY-PB-5C3	LiPF6+DMC+EMC+EC	--	Tested with appliance
-Separator	Hunan Dajing New Material Co., LTD	9+3um*61.5mm	PP+PE, Shutdown temperature: 130°C	--	Tested with appliance
PCB	Dongguan Chengxingrui Electronics Co., LTD	HSX-28	V-0, 130°C	UL94	UL approved
PCB (Alt.)	Interchangeable	Interchangeable	V-0, 130°C	UL 94 UL 796	UL approved
IC (U1)	Shenzhen Developer Microelectronics Co., Ltd.	DW01A	Overcharge Detection Voltage: $4.28 \pm 0.05V$ , Over-discharge Detection Voltage: $2.4V \pm 0.01V$ , Operating temperature range: $-40^{\circ}C \sim +85^{\circ}C$	--	Tested with appliance
MOS (Q1, Q2)	Shenzhen Developer Microelectronics Co., Ltd.	DP8205A	Vds: 20V, Vgs: 4.5V, Id: 5A (TA= 25°C), Operating temperature range: $-55^{\circ}C \sim +150^{\circ}C$	--	Tested with appliance
Wire	Dongguan Yingchang Electronics Co., LTD	UL1007-22#	22AWG, VW-1, 150°C, 300V	--	Tested with appliance

7.2.1	TABLE: Continuous charging at constant voltage (cells)				P
Sample no.	Recommended charging voltage Vc (Vdc)	Recommended charging current I <sub>rec</sub> (A)	OCV before test (Vdc)	Results	
C01	4.20	0.40	4.19	P	
C02	4.20	0.40	4.19	P	
C03	4.20	0.40	4.18	P	
C04	4.20	0.40	4.17	P	
C05	4.20	0.40	4.18	P	
<b>Supplementary information:</b>					
- No fire or explosion					
- No leakage					

7.3.1	TABLE: External short-circuit (cell)					P
Sample no.	Ambient T (°C)	OCV before test (Vdc)	Resistance of circuit (mΩ)	Maximum case temperature rise ΔT, °C	Results	
<b>Samples charged at charging temperature upper limit (45°C)</b>						
C06	55	4.18	80	100.8	P	
C07	55	4.17	80	98.4	P	
C08	55	4.18	80	101.9	P	
C09	55	4.17	80	97.7	P	
C10	55	4.19	80	96.5	P	
<b>Samples charged at charging temperature lower limit (0°C)</b>						
C11	55	4.13	80	97.5	P	
C12	55	4.14	80	95.6	P	
C13	55	4.13	80	96.8	P	
C14	55	4.12	80	95.2	P	
C15	55	4.14	80	92.4	P	
<b>Supplementary information:</b>						
- No fire or explosion						

7.3.2		TABLE: External short-circuit (battery)					P
Sample no.	Ambient T (°C)	OCV before test (Vdc)	Resistance of circuit (mΩ)	Maximum case temperature rise $\Delta T$ , °C	Component single fault condition	Results	
B1	23.5	4.19	80	42.3	Q1	P	
B2	22.75	4.17	80	40.7	Q1	P	
B3	23.4	4.19	80	41.8	Q2	P	
B4	23.3	4.18	80	40.0	Q2	P	
B5	23.2	4.18	80	24.8	--	P	
<b>Supplementary information:</b>							
- No fire or explosion							

7.3.5		TABLE: Crush (cells)			P
Sample no.	OCV before test (Vdc)	OCV at removal of crushing force (Vdc)	Maximum force applied to the cell during crush (kN)	Results	
<b>Samples charged at charging temperature upper limit (45°C)</b>					
C26	4.19	4.19	13.17	P	
C27	4.19	4.18	13.12	P	
C28	4.17	4.17	13.20	P	
C29	4.18	4.18	13.15	P	
C30	4.18	4.17	13.18	P	
<b>Samples charged at charging temperature lower limit (0°C)</b>					
C31	4.13	4.12	13.13	P	
C32	4.13	4.13	13.21	P	
C33	4.14	4.13	13.25	P	
C34	4.15	4.15	13.17	P	
C35	4.14	4.14	13.14	P	
<b>Supplementary information:</b>					
- No fire or explosion					

7.3.6		TABLE: Over-charging of battery			P
Constant charging current (A) :		24.0			—
Supply voltage (Vdc) :		5.88			—
Sample no.	OCV before charging (Vdc)	Total charging time (minute)	Maximum outer case temperature (°C)	Results	
B06	2.92	120	41.7	P	
B07	2.97	120	40.6	P	
B08	2.95	120	42.1	P	
B09	2.98	120	42.8	P	
B10	2.91	120	40.8	P	
<b>Supplementary information:</b> - No fire or explosion					

7.3.7		TABLE: Forced discharge (cells)			P
Sample no.	OCV before application of reverse charge (Vdc)	Measured reverse charge $I_r$ (A)	Lower limit discharge voltage (Vdc)	Results	
C36	2.95	2.0	-4.20	P	
C37	2.94	2.0	-4.20	P	
C38	2.96	2.0	-4.20	P	
C39	2.95	2.0	-4.20	P	
C40	2.91	2.0	-4.20	P	
<b>Supplementary information:</b> - No fire or explosion					

7.3.8.1		TABLE: Vibration				P
Sample no.	OCV before test (Vdc)	OCV after test (Vdc)	Mass before test (g)	Mass after test (g)	Results	
B11	4.18	4.18	256.862	256.861	P	
B12	4.18	4.17	256.684	256.684	P	
B13	4.19	4.18	256.561	256.561	P	
<b>Supplementary information:</b> - No fire or explosion - No rupture - No leakage - No venting						

7.3.8.2 TABLE: Mechanical shock					P
Sample no.	OCV before test (Vdc)	OCV after test (Vdc)	Mass before test (g)	Mass after test (g)	Results
B14	4.18	4.18	256.732	256.731	P
B15	4.17	4.16	256.254	256.254	P
B16	4.19	4.19	256.522	256.521	P

**Supplementary information:**

- No fire or explosion
- No rupture
- No leakage
- No venting

7.3.9 TABLE: Forced internal short circuit (cells)					P
Sample no.	Chamber ambient T (°C)	OCV before test (Vdc)	Particle location <sup>1)</sup>	Maximum applied pressure (N)	Results
<b>Samples charged at charging temperature upper limit (45°C)</b>					
C41	45	4.19	1	800	P
C42	45	4.18	1	800	P
C43	45	4.17	1	800	P
C44	45	4.18	1	800	P
C45	45	4.17	1	800	P
<b>Samples charged at charging temperature lower limit (0°C)</b>					
C46	0	4.13	1	800	P
C47	0	4.13	1	800	P
C48	0	4.12	1	800	P
C49	0	4.14	1	800	P
C50	0	4.15	1	800	P

**Supplementary information:**

<sup>1)</sup> Identify one of the following:

- 1: Nickel particle inserted between positive and negative (active material) coated area.
- 2: Nickel particle inserted between positive aluminium foil and negative active material coated area.

- No fire

## Attachment NO.1

### Photos

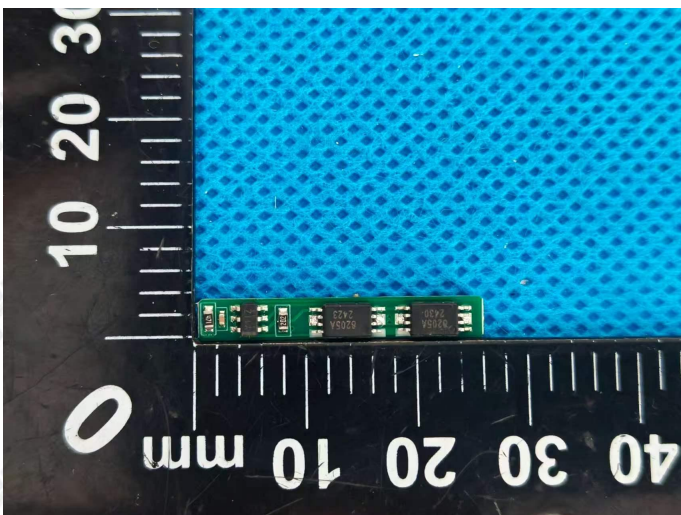
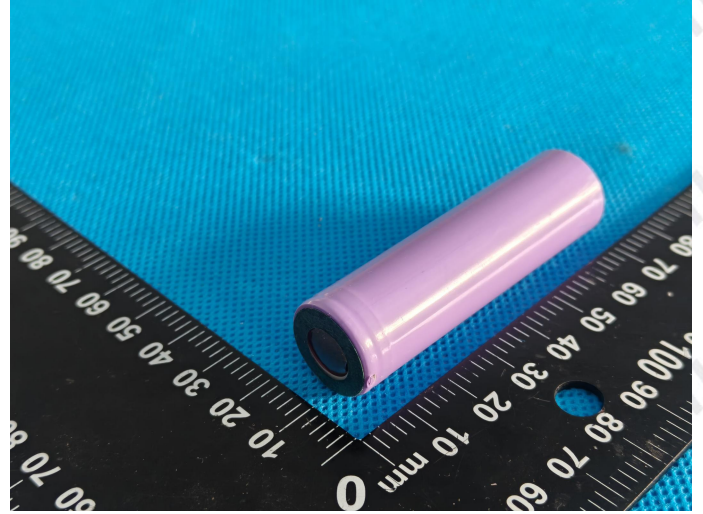
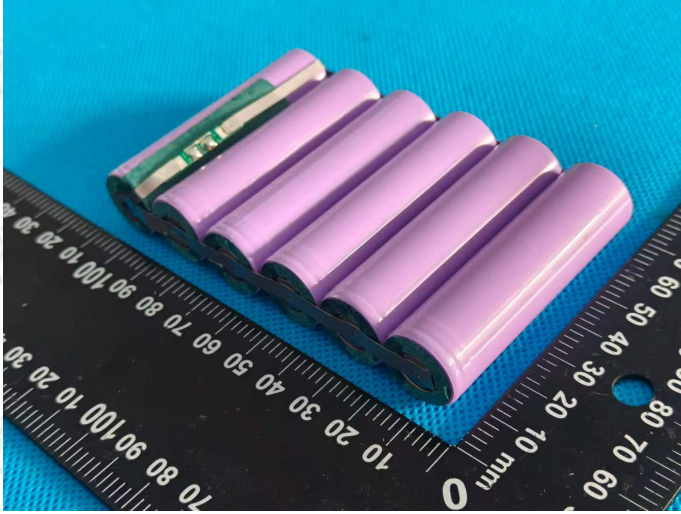
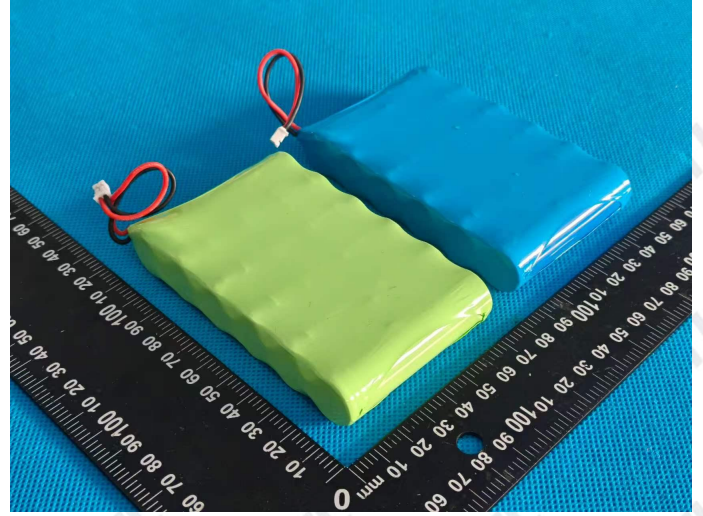
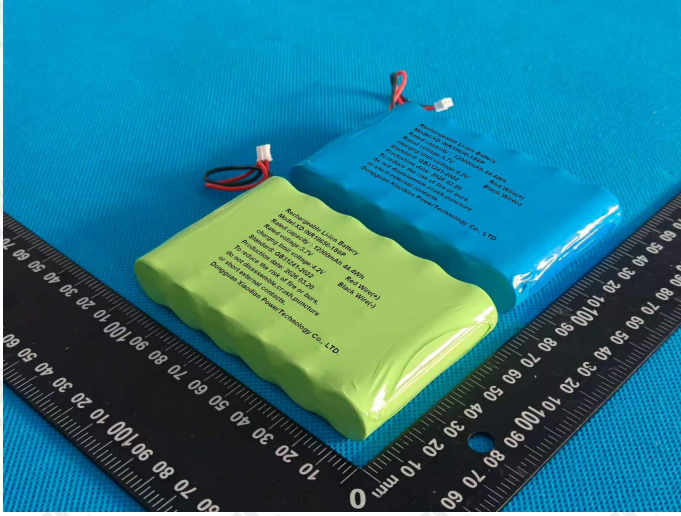

--- End of Report ---